



TAP200



HARDWARE

TOP VIEW

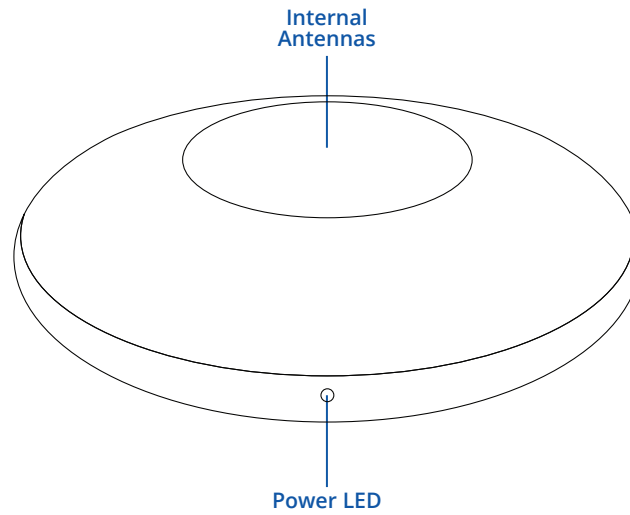

BOTTOM VIEW

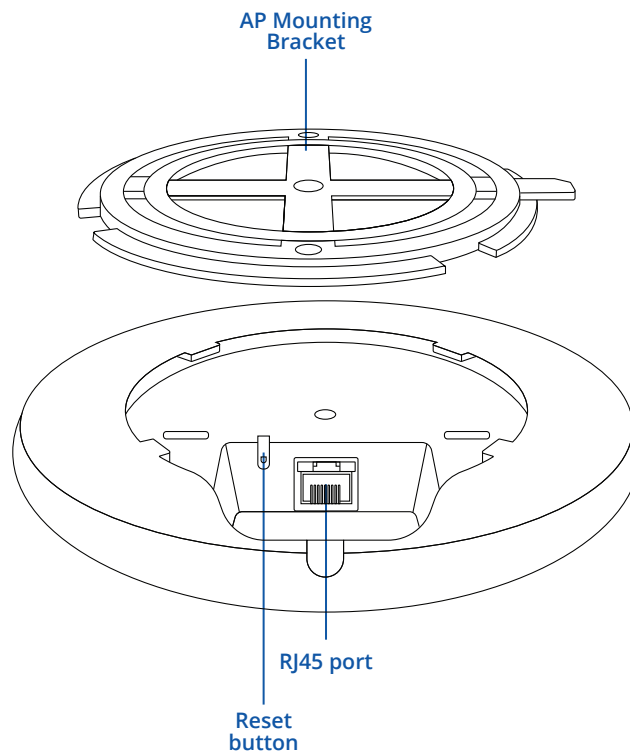

RJ45 LED MEANING

Orange LED on: link established
10/100/1000 Mbps
Orange LED blinking: active connection

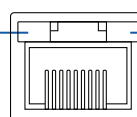

Green LED on: link established
1000Mbps

FEATURES

WIRELESS

Wireless mode	802.11b/g/n/ac Wave 2 (Wi-Fi 5) with data transmission rates up to 867 Mbps (Dual Band, MU-MIMO)
Wi-Fi security	WPA2-Enterprise - PEAP, WPA2-PSK, WPA-EAP, WPA-PSK, WPA3-SAE, WPA3-EAP, OWE; AES-CCMP, TKIP, Auto-cipher modes, client separation, EAP-TLS with PKCS#12 certificates, disable auto-reconnect
SSID/ESSID	ESSID stealth mode (Hide SSID)
Wi-Fi users	Up to 100 simultaneous connections
Wireless Connectivity Features	Wireless mesh (802.11s), fast roaming (802.11r), BSS transition management (802.11v), radio resource measurement (802.11k)
Wireless MAC filter	Whitelist, blacklist
Wireless QR code generator	Once scanned, a user will automatically enter your network without needing to input login information

ETHERNET

Ethernet	1 x RJ45 10/100/1000 Mbps, compliance with IEEE 802.3, IEEE 802.3u, 802.3az standards, supports auto MDI/MDIX crossover
----------	---

NETWORK

Network protocols	TCP, UDP, IPv4, IPv6, ICMP, HTTP, HTTPS, SSL v3, TLS, ARP, SSH
DNS over HTTPS	DNS over HTTPS proxy enables secure DNS resolution by routing DNS queries over HTTPS
Hotspot	Captive portal (hotspot), internal/external Radius server, Radius MAC authentication, SMS authorisation, SSO authentication, internal/external landing page, walled garden, user scripts, URL parameters, user groups, individual user or group limitations, user management, 9 default customisable themes and optionality to upload and download customised hotspot themes

SECURITY

802.1x	Port-based network access control client
Authentication	SSH key based, HTTPS, CLI, IP & Login attempts block, time-based login blocking, built-in random password generator
VLAN	Tag-based VLAN separation

DATA TO SERVER

Protocol	HTTP(S), MQTT, Azure MQTT, Kinesis
Data to server	Extract parameters from multiple sources and different protocols, and send them all to a single server; Custom LUA scripting, allowing scripts to utilize the router's Data to server feature

API

Teltonika Networks Web API (beta) support	Expand your device's possibilities by using a set of configurable API endpoints to retrieve or change data. For more information, please refer to this documentation: https://developers.teltonika-networks.com
---	---

MONITORING & MANAGEMENT

WEB UI	HTTP/HTTPS, status, configuration, FW update, CLI, troubleshoot, multiple event log servers, firmware update availability notifications, event log, system log, kernel log
FOTA	Firmware update from server, automatic notification
SSH	SSH (v1, v2)
Email	Receive email message status alerts of various services
JSON-RPC	Management API over HTTP/HTTPS
RMS	Teltonika Remote Management System (RMS)

SYSTEM CHARACTERISTICS

CPU	MediaTek, Dual-Core, 880 MHz, MIPS 1004Kc
RAM	256 MB, DDR3
FLASH storage	16MB, SPI NOR Flash

FIRMWARE / CONFIGURATION

WEB UI	Update FW from file, check FW on server, configuration profiles, configuration backup
FOTA	Update FW
RMS	Update FW/configuration for multiple devices at once
Keep settings	Update FW without losing current configuration
Factory settings reset	A full factory reset restores all system settings, including the IP address, PIN, and user data to the default manufacturer's configuration

FIRMWARE CUSTOMISATION

Operating system	RutOS (OpenWrt based Linux OS)
Supported languages	Busybox shell, Lua, C, C++
Development tools	SDK package with build environment provided
GPL customization	You can create your own custom, branded firmware and web page application by changing colours, logos, and other elements in our firmware to fit your or your clients' needs
Package Manager	The Package Manager is a service used to install additional software on the device

POWER

Connector	RJ45 Socket
Input voltage range	44.0 – 57.0 V
PoE standards	802.3af PoE Class 1
Power consumption	Idle: < 4 W / Max: < 5.5 W

PHYSICAL INTERFACES

Ethernet	1 x RJ45 port, 10/100/1000 Mbps
Status LEDs	1 x Power LED (can be turned off from web-UI)
Antennas	2 x Internal for 2.4 GHz Wi-Fi, 2 x Internal for 5 GHz Wi-Fi
Antennas specifications	2 x 2400 - 2500 MHz, 50 Ω, VSWR <2.7, gain < 4.9 dBi, omnidirectional 2 x 5150 - 5850 MHz, 50 Ω, VSWR <2, gain < 5.02 dBi, omnidirectional
Reset	Reboot/User default reset/Factory reset button

PHYSICAL SPECIFICATION

Casing material	UV stabilized plastic
Dimensions	Ø 158 mm x 30 mm
Weight	190 g
Mounting options	AP mounting bracket (for ceiling mount)

OPERATING ENVIRONMENT

Operating temperature	-40 °C to 75 °C
Operating humidity	10% to 90% non-condensing for all our devices.
Ingress Protection Rating	IP30

REGULATORY & TYPE APPROVALS

Regulatory	CE, UKCA, FCC, IC, RCM, CB, EAC, UCRF, RoHS, REACH, WEEE, SDPPI (POSTEL)
------------	--

EMC EMISSIONS & IMMUNITY

Standards	EN 55032:2015 + A11:2020 EN 55035:2017 + A11:2020 EN 61000-3-3:2013+A1:2019 + A2:2021 EN IEC 61000-3-2:2019 + A1:2021 EN 301 489-1 V2.2.3 EN 301 489-17 V3.2.4
ESD	EN 61000-4-2:2009
Radiated Immunity	EN IEC 61000-4-3:2020
EFT	EN 61000-4-4:2012
Surge Immunity (AC Mains Power Port)	EN 61000-4-5:2014 + A1:2017
CS	EN 61000-4-6:2014
DIP	EN IEC 61000-4-11:2020

RF

Standards	EN 300 328 V2.2.2 EN 300 893 V2.1.1 EN 300 440 V2.2.1
-----------	---

SAFETY

Standards	CE: EN IEC 62368-1:2020 + A11:2020, EN IEC 62311:2020 RCM: AS/NZS 62368.1:2022 CB: IEC 62368-1:2018
-----------	---

STANDARD PACKAGE*

- Access Point TAP200
- QSG (Quick Start Guide)
- Wi-Fi Information sticker
- Packaging box



CLASSIFICATION CODES

HS Code: 851762

HTS: 8517.62.00

For more information on all available packaging options – please contact us directly.

AVAILABLE VERSIONS

HARDWARE VERSION	SUPPORTED FREQUENCIES	STANDARD ORDER CODE / PACKAGE CONTAINS
TAP200 *****	N/A	TAP200000000 / Standard package TAP200000300 / Standard package with EU PoE injector TAP200000100 / Standard package with UK PoE injector TAP200000500 / Standard package with US PoE injector

TAP200 SPATIAL MEASUREMENTS

MAIN MEASUREMENTS

Dimensions for TAP200:

Device housing*: \varnothing 158 mm x 30 mm
 Box: 355 mm x 175 mm x 60 mm

TOP VIEW

The figure below depicts the measurements of TAP200 and its components as seen from the top:

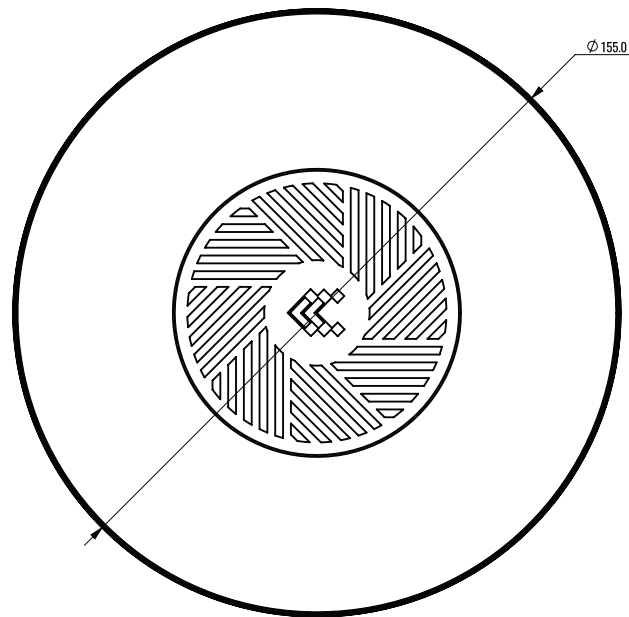

BOTTOM VIEW

The figure below depicts the measurements of TAP200 and its components as seen from the bottom side:

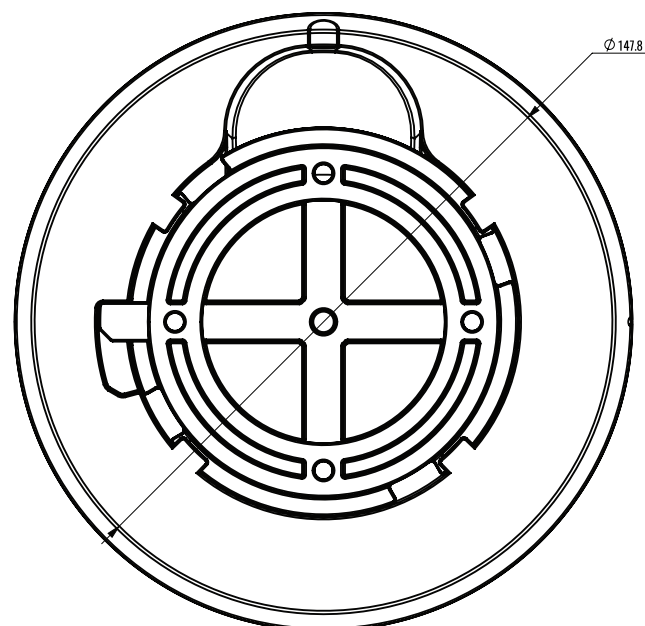

SIDE VIEW

The figure below depicts the measurements of TAP200 and its components as seen from the front panel side:

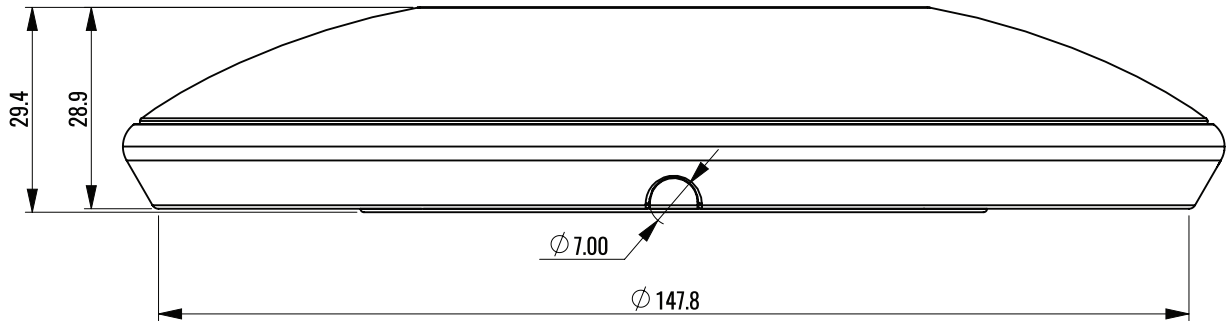

MOUNTING SPACE REQUIREMENTS

The figure below depicts an approximation of the device's dimensions when cables and antennas are attached:

